

Implementation of Temperature and Humidity Control Devices in IOT-Based Hydroponic Peppermint Cultivation at Sufiagrifarm Slawi

Donny Maulana*¹, Irfan Afriantoro²

Pelita Bangsa University, Jl. Inspection Kalimalang Tegal Danas Cikarang Pusat Jawa Barat, (021) 2851 8181

E-mail : donny.maulana@pelitabangsa.ac.id¹, irfanafriantoro@pelitabangsa.ac.id²

Abstract - Along with the rapid development of existing technology, especially in the field of information and the *Internet of Things (IoT)*, which is developing so fast and producing a lot of benefits to help humans both in the field of education and in manufacturing and agriculture. But at this time there are still so many technologies that still cannot be implemented in certain fields, for example like agriculture, where everything is still done manually so that it takes a lot of time, costs and also more energy in the process. Such as the constraints that exist with Sufiagrifarm, where in this case to meet the needs of temperature and humidity in Peppermint plants *that* use a hydroponic planting *system* it is still done manually by spraying the plants with a spray that produces dew. Given these problems, this research aims to assist Sufiagrifarm in overcoming problems in regulating temperature and humidity in *peppermint plants* so that temperature and humidity compliance in *peppermint plants* can be carried out automatically and can be *monitored in real time*. Development in this method is carried out using the SDLC *Waterfall method*. This application was created using the Java programming language using the *MITApp inventor platform*, for the tool itself it was made using an Arduino microcontroller with the C programming language supported by several other devices such as *Thingspeak*. The results of this study are to help fulfill temperature and humidity in peppermint cultivation at Sufiagrifarm.

Keywords - Peppermint, Temperature, Humidity, *IoT*, Arduino, SDLC

1. INTRODUCTION

The development of science and technology, especially information technology has been very advanced and has penetrated into every area of our lives. Almost all human activities use the help of modern technology, from the industrial world to households and agriculture. Many technologies that can be used automatically and repeatedly are very beneficial for human work in terms of time and effort. In addition, the Internet of Things (IoT) will make it easier for people to carry out activities both at work and in everyday life. With this IoT, people can get information anywhere and anytime because IoT itself uses internet media to send or receive information using a device that has been programmed [1].

Sufiagrifarm is one of the SMEs that cultivates various vegetables with a hydroponic planting system such as pakcoy, mint leaves, red spinach, etc. Sufiagrifarm itself is an MSME that is quite well-known in Slawi, Tegal Regency, Sufiagrifarm is an MSME that stands under PT. Dimargatyo Teguh Jaya, in this case Sufiagrifarm itself is targeting its sales market to the surrounding community, as well as educating the surrounding community. However,

Sufiagrifarm has several obstacles in terms of agriculture, one of which is the cultivation of mint which can grow at an altitude of 100-900 meters above sea level, at a temperature of 20-30 °C and 80% - 95% humidity with full light intensity. Meanwhile, the average temperature in the Sufiagrifarm field can reach more than 30°C in the afternoon.

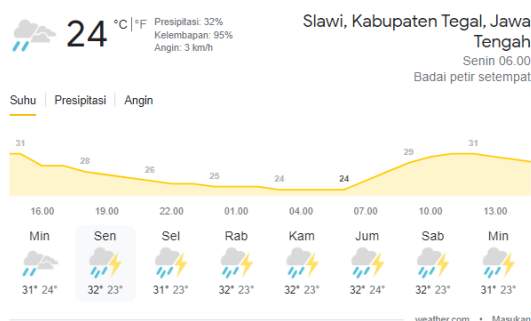

Figure 1. Slawi City Temperature Data 202 2 Source: <https://weather.com>

Based on the background above, the problems faced can be stated as follows: how to build a temperature and humidity control device that can be controlled in real time to maximize hydroponic peppermint cultivation.

2. RESEARCH METHOD

The waterfall method is a systematic and sequential information system development model [2]. In this study the waterfall method will be used , this method has a sequential and systematic approach based on the stages of the System Development Life Cycle (SDLC) which consists of five stages namely analysis, design, programming, testing. testing) and maintenance (maintenance). And the following is a description of the stages in the waterfall method which was carried out in this study [3]:

1. Analysis

In the scope of this analysis stage, the researcher will carry out an analysis of the system requirements that will be executed later. Where in this stage the researcher collects the necessary data, such as the temperature and humidity data needed in the peppermint cultivation itself. Besides that, in this stage the researcher also conducted an analysis of the needs of the tools and materials needed in making this tool.

2. Design

At this stage the author makes a design of the existing system model using a flowchart in describing a system that will run by pouring out the logic that will be used. In this stage the researcher uses the Unified Modeling Language (UML) which includes use case diagrams, activity diagrams, sequence diagrams, class diagrams [4].

3. Programming

After the design stage, in this stage the author will start making programs so that the device can work according to the algorithm that has been made, in this case the author uses the C++ programming language in Arduino programming for making tools, while for the monitoring application itself the author uses the Java programming language [5].

4. Testing

At this testing stage, the development of the modules that have been made for *testing* will be carried out. This test is carried out to find out that the *IoT device* or *monitoring software* can run properly, and there are no errors in the program. In this test the author uses the *black box method* , where the tester only focuses on functional testing of applications and devices [6].

5. Operation and Maintenance

This is the longest stage, because in this stage it is necessary to maintain the equipment if there is damage or updates to existing technological developments, both functionally and updates to existing software [3].

3. RESULTS AND DISCUSSION

3.1 Theoretical basis

The results of the analysis of the system running on Sufiagrifarm and the design of the new system that has been proposed, the authors carry out the implementation in this study. And the following is a sub-chapter regarding the results and discussion of " Making Temperature and Humidity Control Devices in lot - Based Hydroponic Peppermint Cultivation in Sufiagrifarm Slawi ", namely:

1. He made Temperature and Humidity Regulators

In implementing the temperature and humidity control device in the peppermint cultivation area, a tool was made to be able to fulfill the temperature and humidity requirements.

2. Temperature and Humidity Monitoring Application Made

To assist the process of monitoring temperature and humidity, an Android-based application was created so that it can be used in real time for monitoring needs.

3. Built an API on Thingspeak

API is used as a third party to store temperature and humidity data which is then sent to monitoring applications. Data on thingspeak will be stored for later evaluation or repair of the tool.

3.2 Analysis

3.2.1 Running System

To describe the procedure and explanation of the flow of data from the system that is currently running, therefore I made, what is the process flow of the activity and who are the actors involved in it. The following is a flowmap of the running system:

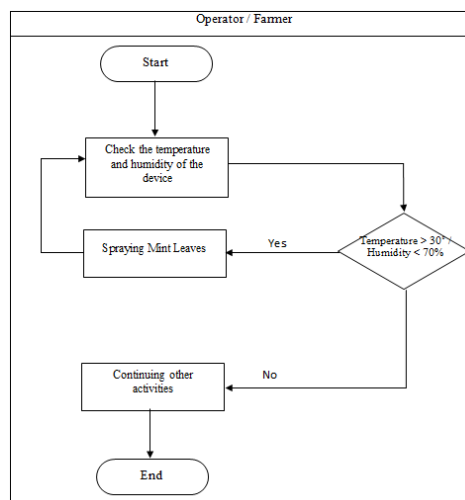

Figure 2. Use Case Diagram

3.2.2 Proposed System Flowchart

After seeing the system that is running, the researchers have a system that is considered more effective in maintaining the temperature and humidity of mint leaves according to their habitat. Here is a flowchart of the proposed system [7]:

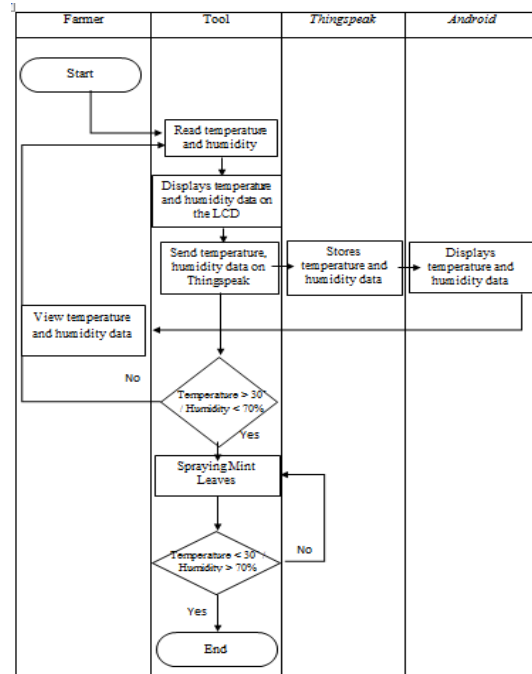

Figure 3. Use Case Diagrams

3.3 Design

3.3.1 Use cases Diagram

use case is a series or description of a group that are interrelated and form a routine system that is executed or controlled by an actor. Diagram use case describes the interaction between one or more actors and the system created[8].

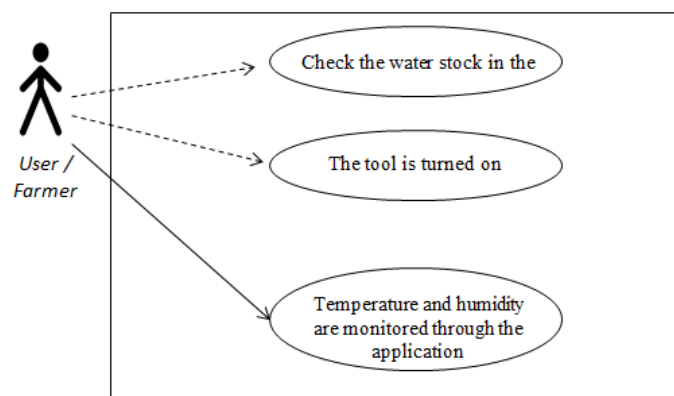

Figure 4. Use Case Diagrams

3.3.2 Activity Diagram

or activity diagrams are modeling carried out on a system and describe the activity of a running system [9]. Considering the use cases and scenarios before the user activity diagram of

the temperature and humidity device automation system on the Sufiagrifarm peppermint cultivation is as follows:

1. Activity diagram of Application for monitoring Temperature and Humidity

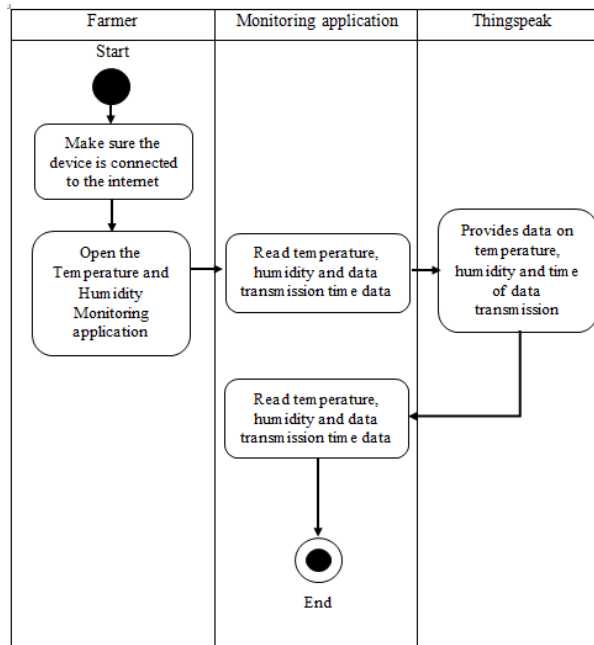

Figure 5. Activity Diagrams

3.3.3 Sequence Diagrams

Sequence diagrams depict interactions by marking each participant with a lifeline that runs vertically down the page and the order of messages by reading downwards on the page [10]. The following is the sequence a diagram that will describe the interaction between objects in the temperature and humidity device automation system on the Sufiagrifarm peppermint cultivation, as well as explain in detail the process flow of the system used and explain the data displayed.

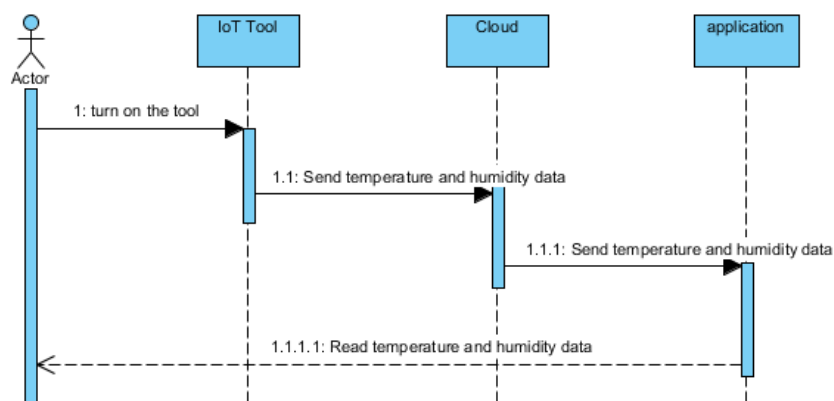

Figure 6. Sequences diagram of Temperature and Humidity Regulators

3.3.4 Deployment Diagrams

Deployment or physical diagram describes how to deploy the information of the components in the system infrastructure, on which machines they are located (servers or

hardware), what are the network capabilities like at that location, server specifications, and other physical things [11].

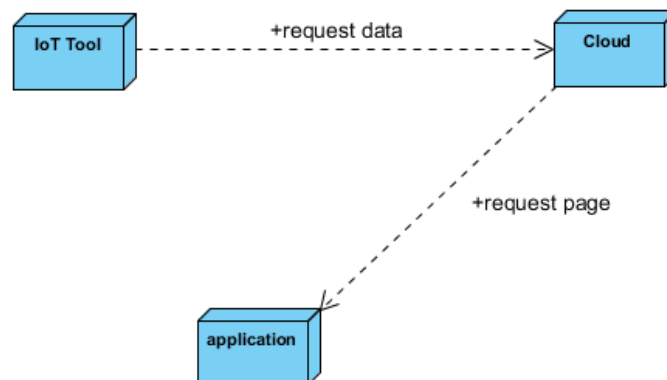

Figure 7. Deployment Diagrams

3.3.5 Tool Design

Tool design is the process of designing and developing tools, methods and techniques to increase manufacturing efficiency and productivity [12]. Prepare special machines and tools for current production needs. This is the structure of the temperature and humidity control device:

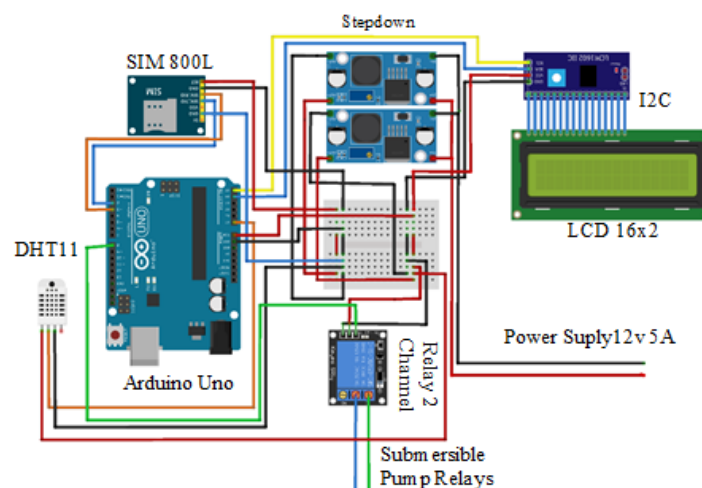

Figure 8. Tool Design

3.4 Programming

After all the design designs have been fulfilled, then to the programming stage which is a series of instructions or statements in a language that is understood by the computer in question [13]:

1. Arduino programming for making tools using the C++ programming language.
2. Monitoring application for monitoring tools using the *Java programming language*.

3.5 Testing

The system testing technique uses Black Box Testing . Tests performed are only to verify execution results using test data and to verify software functionality [14]. In this study, testing was carried out using the black box method and testing tools, while the test results are as follows:

1. Monitoring Tools and Applications

Table 1. Testing Tools and Applications for Monitoring Temperature and Humidity

No	Test Scenario	Expected results	Research result	Validation
1.	Connecting DHT11 to Arduino Uno as well as 6x2 LCD	The DHT11 can read temperature and humidity, then displays the data on a 6x12 LCD	The temperature and humidity can be read by the DHT11 and displayed on the 6x12 LCD	Valid
2.	Connect SIM 800L to the internet and connect to Thingspeak	SIM 800L can connect to the internet and can read and send temperature and humidity data to thingspeak	SIM 800L is connected to the internet , and data is sent to thingspeak	Valid
3.	Connecting 2 channel relay control to Arduino Uno	The relay can turn on the pump if the temperature of the cultivation area is more than 30°C and or the humidity is less than 72%	The pump starts when the temperature of the cultivation area is more than 30°C and or the humidity is less than 72%	Valid
		The relay can turn off the pump if the temperature of the cultivation area is less than or equal to 30°C and or the humidity is more or equal to 72%.	The pump stops when the temperature of the cultivation area is less than or equal to 30°C and or the humidity is more or equal to 72%.	Valid
4.	Connecting 6x2 LCD on Arduino Uno	LCD 6x12 Can display temperature and humidity data and tool processes	The 6x12 LCD displays temperature and humidity data and the process of the tool	Valid
5.	Connecting thingspeak with Arduino using the API keys obtained	Thingspeak can store temperature and humidity data sent by the device/ SIM800L	Thingspeak stores data that is sent by the device/ SIM800L	Valid
6.	Open the temperature and humidity monitoring application on the smartphone	Applications can display temperature and humidity data as well as the date of the last data transmission	The application displays temperature and humidity data and displays the history of data transmission	Valid

2. Tool Testing Results

After testing the system on the tool, the researcher also tested the tool so that it could prove the tool's performance in regulating the temperature and humidity that had been set on the tool [15]. And the following is the data from the testing tool:

Table 2. Tool Testing Results

No	O'clock	Temperature	humidity	Action	Information
1	12:25	30°	75%	Pump Off	-
2	12:26	30°	75%	Pump Off	-
3	12:27	31°	81%	Pump On	-
4	12:28	32°	85%	Pump On	-
5	12:30 p.m	30°	85%	Pump Off	-
6	12:32	30°	85%	Pump Off	-
7	12:33	30°	85%	Pump Off	-
8	12:34	30°	85%	Pump Off	-
9	12:35	31°	85%	Pump On	-

10	12:36	29°	85%	Pump Off	-
11	12:38	30°	85%	Pump Off	-
12	12:39 p.m	30°	83%	Pump Off	-
13	12:41	27°	85%	Pump Off	-
14	12:42	29°	85%	Pump Off	-
15	12:43	31°	85%	Pump On	-
16	12:44	32°	85%	Pump On	-
17	12:46	29°	85%	Pump Off	-
18	12:47	29°	85%	Pump Off	-
19	12:48	30°	83%	Pump Off	-
20	12:49 p.m	30°	83%	Pump Off	-
21	12:50 p.m	0°	0%	Pump On	Sensor not read
22	12:51	30°	85%	Pump Off	-
23	12:52	30°	85%	Pump Off	-
24	12:53	31°	85%	Pump On	-
25	12:54	31°	85%	Pump On	-

From the results of the data obtained, the researcher can calculate the percentage of success and failure of the tool in sending data obtained by the tool using the following formula:

Percentage (%) = (number of shares) / (total number) X 100%

Success Percentage (%) = (Failure Percentage) – 100%

So:

Percentage (%) = 1 / 25 X 100% = 4%

Success Percentage (%) = (4%) – 100% = 96%

3.6 Monitoring Application Interface Display

1. Monitoring Application Icon Interface Display

Before entering into the application the icon of the application will be displayed so that the application has characteristics to be immediately recognized by the user. On the logo/icon of this application there is an image of water droplets which symbolize humidity and also a thermometer which represents temperature.

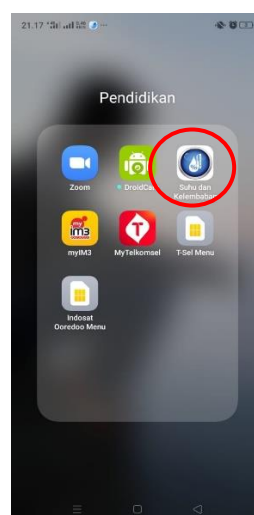

Figure 9. Monitoring Application Icon Display

2. Temperature and Humidity Data Interface Display

After the user enters the monitoring application , the user will immediately be presented with several data displays which include temperature, humidity data and information on the last

data transmission sent by the device. This display is deliberately made so simple and easy to use so as not to make it difficult for farmers when checking temperature and humidity in real time.



Figure 10. Display of Monitoring Application Data

3.7 Tool Implementation

1. Display of Temperature and Humidity Regulators

The implementation of this tool aims to help farmers meet the temperature and humidity requirements in peppermint cultivation automatically and can be monitored in real time with the application of IoT on Android-based tools and applications.



Figure 11. Display of the Temperature and Humidity Control Tool

2. Tool LCD display

The display tool for this tool is also equipped with an LCD to display temperature and humidity data as well as ongoing processes, if the tool is running, adjusting the temperature and humidity will display the words "Cooling Process" on this LCD display, and when the process is complete, the information on the LCD will be changed to "Good".



Figure 12. LCD Temperature and Humidity Control Device

3.8 Thingspeak Data View

This tool also runs with Thingspeak as an API and is also used to store temperature and humidity data sent by the tool, from the data collected this can be used for monitoring the success of the tool, maintenance, and can be used for future tool repairs [16].

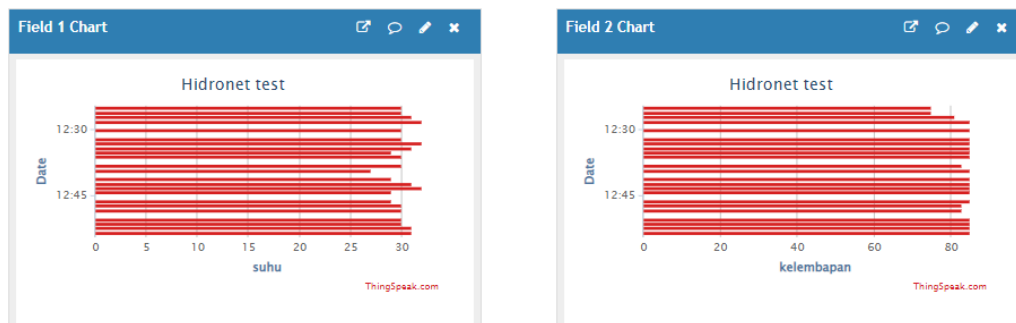

Figure 13. Thingspeak Temperature and Humidity Data

4. CONCLUSION

Based on the results of the analysis, planning, implementation and testing of the needs of Sufiagrifarm researchers, the authors can conclude that:

1. Based on the data recorded in the implemented program, it can be concluded that the temperature and humidity controllers of peppermint plants are able to read temperature and humidity.
2. This tool can also read the temperature and humidity periodically and send it to Thingspeak. This allows temperature and humidity monitoring applications to read them in real time.
3. Evidenced by the data available on Thingspeak, this tool can be used to stabilize the temperature and humidity of the peppermint growing area.

REFERENCES

- [1] Arafat, "SISTEM PENGAMANAN PINTU RUMAH BERBASIS Internet Of Things (IoT) Dengan ESP8266," J. Ilm. Fak. Tek. "Technologia," vol. 195, no. 4279, p. 639, 1977, doi: 10.1126/science.195.4279.639.
- [2] O. Irnawati, "Implementasi Metode Waterfall Pada Sistem Informasi Stock Opname," Indones. J. Softw. Eng., vol. 4, no. 1, pp. 202–211, 2018, doi: 10.31294/ijse.v4i1.6301.
- [3] A. A. Wahid, "Analisis Metode Waterfall Untuk Pengembangan Sistem Informasi," J. Ilmu-ilmu Inform. dan Manaj. STMIK, no. November, pp. 1–5, 2020.

- [4] R. Andarsyah and R. Abdul Ghani Siherli, "Analisis Dan Implementasi Aplikasi Pembayaran Instan Menggunakan Virtual Account Berbasis Android Pada Pt. Pos Indonesia (Persero)," *J. Tek. Inform.*, vol. 12, no. 1, pp. 15–21, 2020.
- [5] S. Samsugi, A. Ardiansyah, and D. Kastutara, "Arduino dan Modul Wifi ESP8266 sebagai Media Kendali Jarak Jauh dengan antarmuka Berbasis Android," *J. Teknoinfo*, vol. 12, no. 1, p. 23, 2018, doi: 10.33365/jti.v12i1.42.
- [6] P. Astuti, "Penggunaan Metode Black Box Testing (Boundary Value Analysis) Pada Sistem Akademik (Sma/Smk)," *Fakt. Exacta*, vol. 11, no. 2, p. 186, 2018, doi: 10.30998/faktorexacta.v11i2.2510.
- [7] J. R. Fauzi, "Algoritma Dan Flowchart Dalam Menyelesaikan Suatu Masalah," *J. Tek. Inform.*, 2020, [Online]. Available: https://www.academia.edu/44752713/MAKALAH_ALGORITMA_DAN_FLOWCHART
- [8] M. Tabrani and I. Rezqy Aghniya, "Implementasi Metode Waterfall Pada Program Simpan Pinjam Koperasi Subur Jaya Mandiri Subang," *J. Interkom J. Publ. Ilm. Bid. Teknol. Inf. dan Komun.*, vol. 14, no. 1, pp. 44–53, 2020, doi: 10.35969/interkom.v14i1.65.
- [9] H. Kurniawan, W. Apriliah, I. Kurnia, and D. Firmansyah, "Penerapan Metode Waterfall Dalam Perancangan Sistem Informasi Penggajian Pada Smk Bina Karya Karawang," *J. Interkom J. Publ. Ilm. Bid. Teknol. Inf. dan Komun.*, vol. 14, no. 4, pp. 13–23, 2021, doi: 10.35969/interkom.v14i4.78.
- [10] M. Fowler, "UML Distilled: A Brief Guide to the Standard Object Modeling Language," pp. 1–118, [Online]. Available: <https://www.ptonline.com/articles/how-to-get-better-mfi-results>
- [11] N. A. Maiyendra, "Perancangan Sistem Informasi Promosi Tour Wisata Dan Pemesanan Paket Tour Wisata Daerah Kerinci Jambi Pada Cv. Rinai Berbasis Open Source," *Jursima*, vol. 7, no. 1, p. 1, 2019, doi: 10.47024/js.v7i1.164.
- [12] A. P. Zanofa, R. Arrahman, M. Bakri, and A. Budiman, "Pintu Gerbang Otomatis Berbasis Mikrokontroler Arduino Uno R3," *J. Tek. dan Sist. Komput.*, vol. 1, no. 1, pp. 22–27, 2020, doi: 10.33365/jtikom.v1i1.76.
- [13] A. Afrizal Subhan, "Rancang Bangun Aplikasi Pembelajaran Dasar Pemrograman Berbasis Mobile Phone," *J. Tek. Inform. Politek. Sekayu*, vol. 6, no. 1, pp. 4–19, 2017.
- [14] A. Ardian and Y. Fernando, "Sistem Informasi Manajemen Lelang Kendaraan Berbasis Mobile (Studi Kasus Mandiri Tunas Finance)," *J. Teknol. dan Sist. Inf.*, vol. 1, no. 2, pp. 10–16, 2020, [Online]. Available: <http://jim.teknokrat.ac.id/index.php/JTSI>
- [15] A. feri, R. Syelly, and P. Studi Teknik Komputer Sekolah Tinggi Teknologi Payakumbuh JKhatib Sulaiman Sawah Padang Kota Payakumbuh, "Rancang Bangun Sistem Pengatur Suhu Dan Kelembaban Pada Kubung Jamur Tiram Menggunakan Sensor Dht 11 Dan Arduino," *J. SIMTIKA*, vol. 4, no. 1, pp. 14–20, 2022, [Online]. Available: <https://www.circuito.io/>
- [16] S. I. Dody, Hidayat, "Platform Thingspeak," *Univ. Sriwij.*, vol. 4, no. April, pp. 525–530, 2021, [Online]. Available: http://edocs.ilkom.unsri.ac.id/474/1/09011181320003_UlanPurnamaSari_TASK2.pdf